

a**b****c****d****e**

a**MGST1** NM_020300.4**b****c****Patient #73804****d**

Intensity of hydroethidine oxidation products

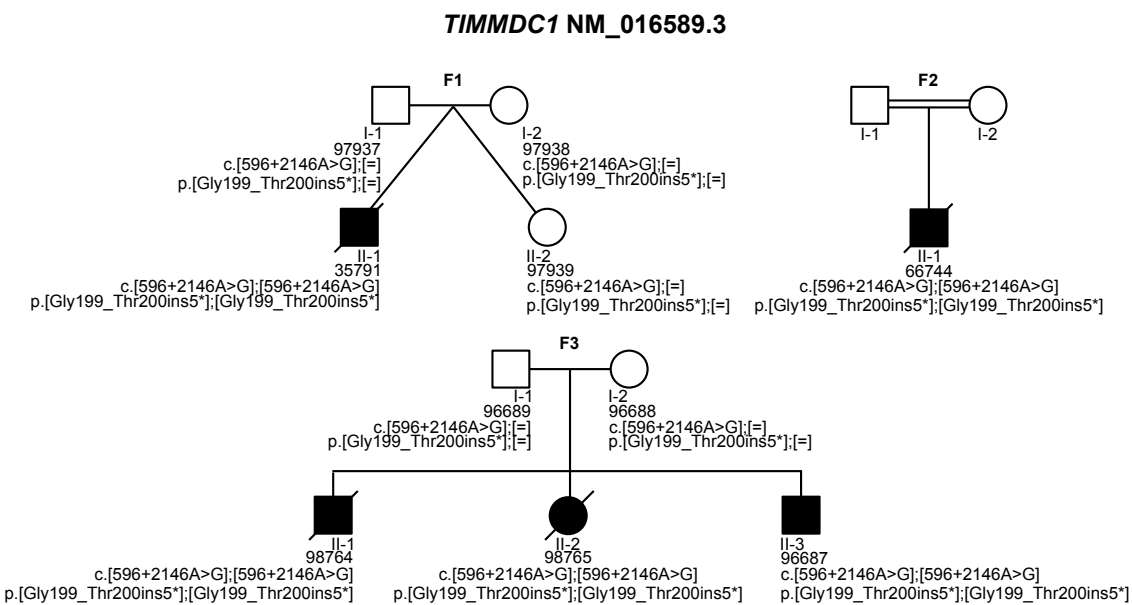
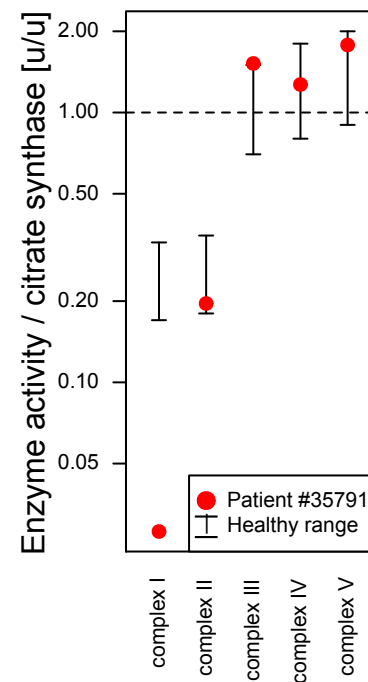
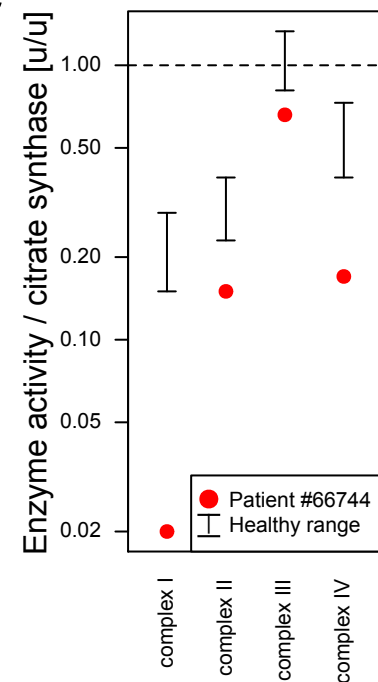
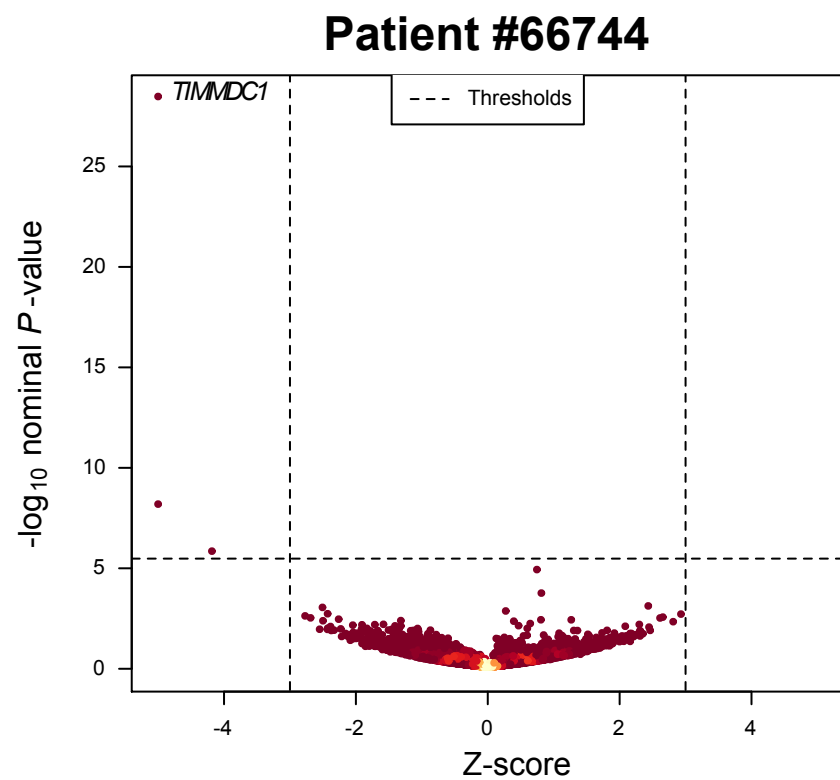
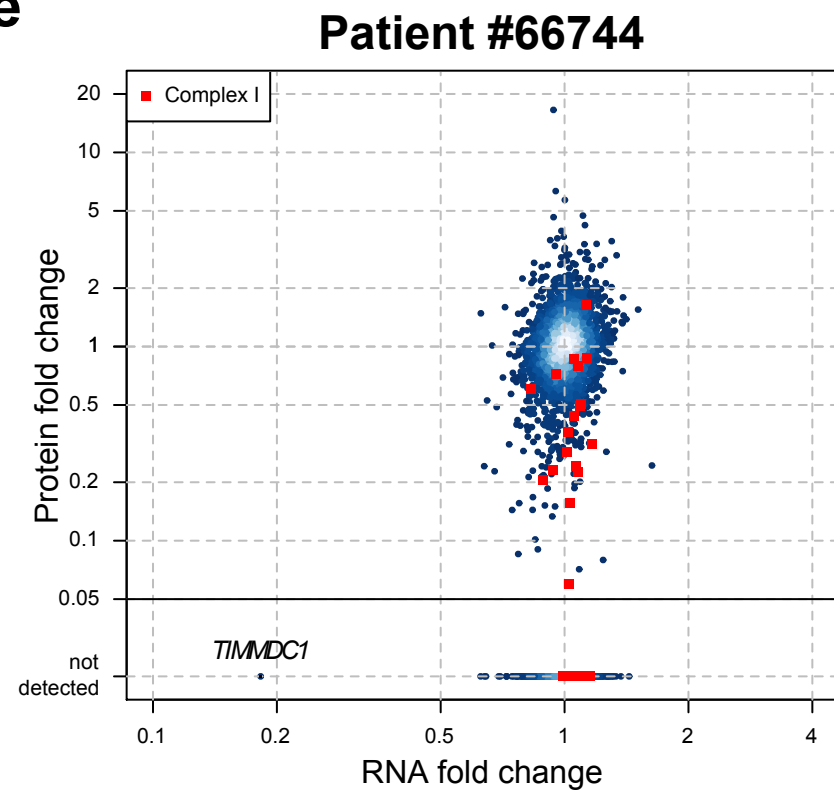
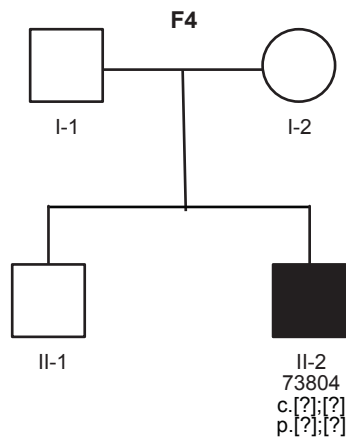
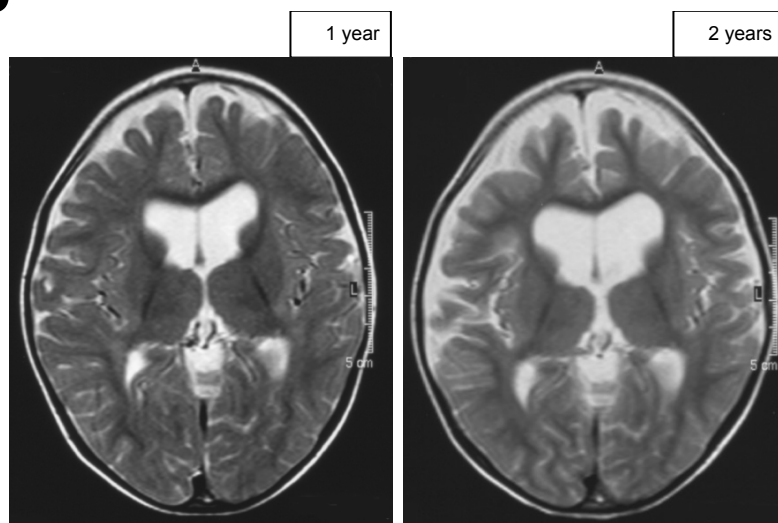
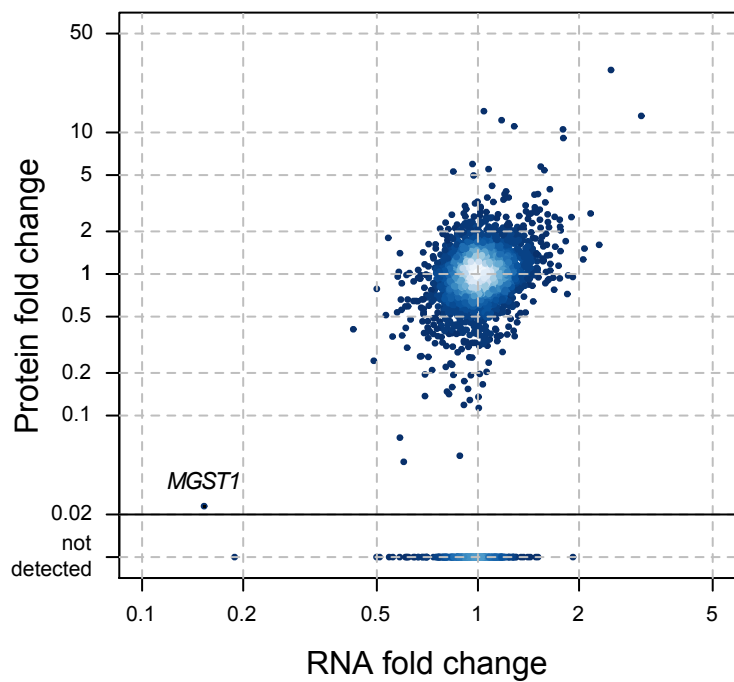
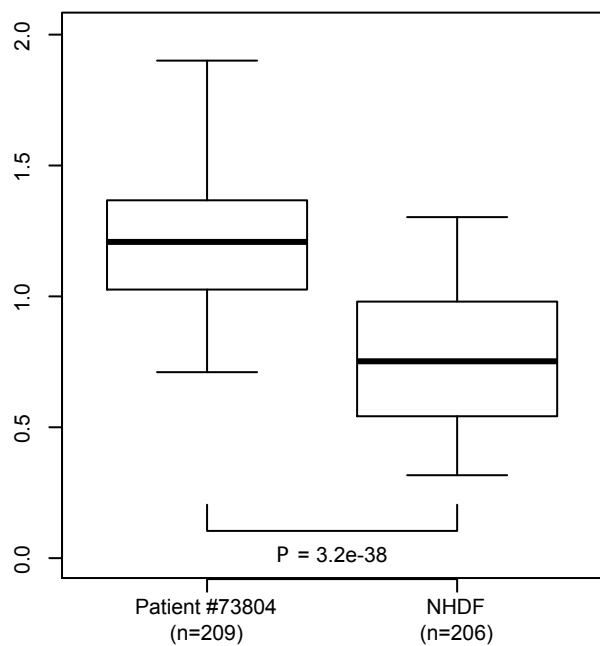
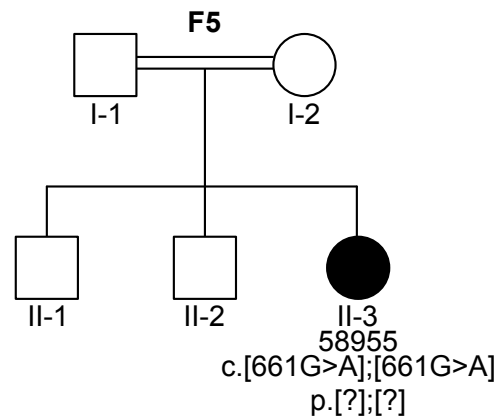
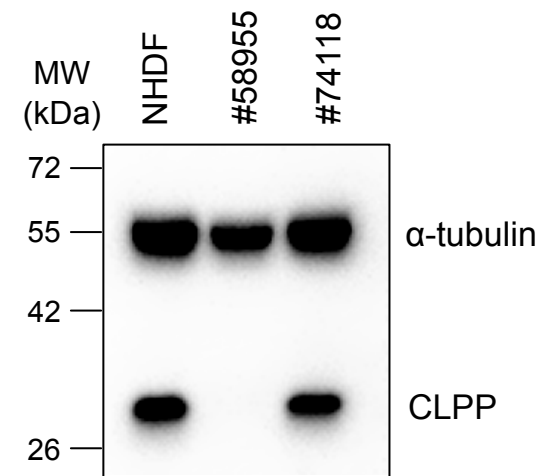
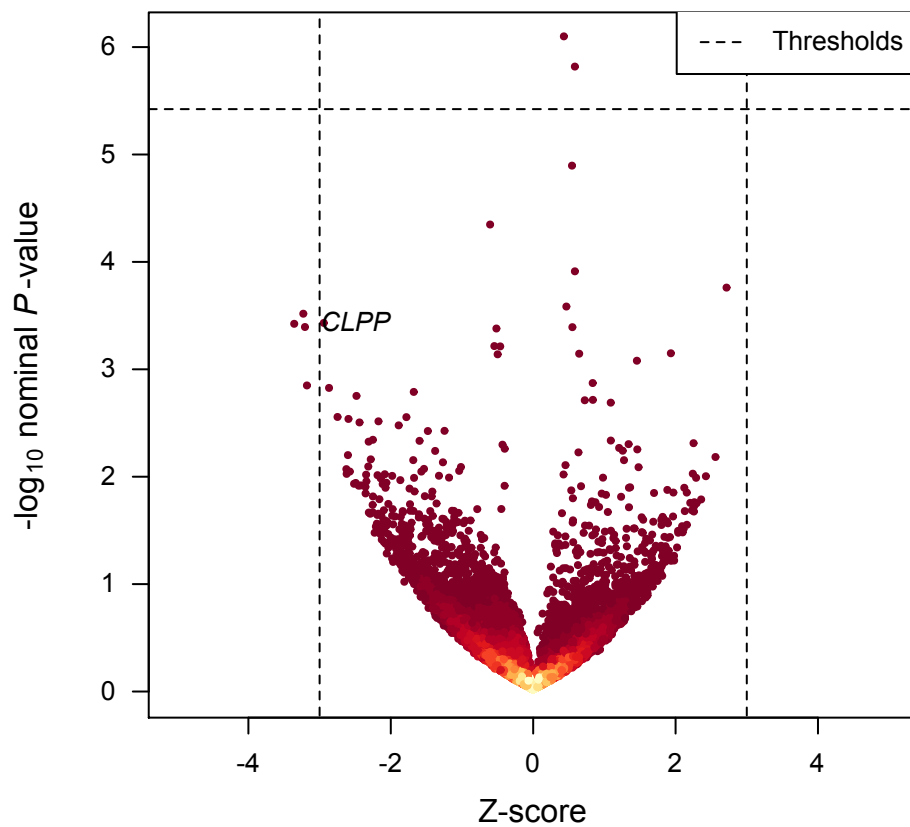
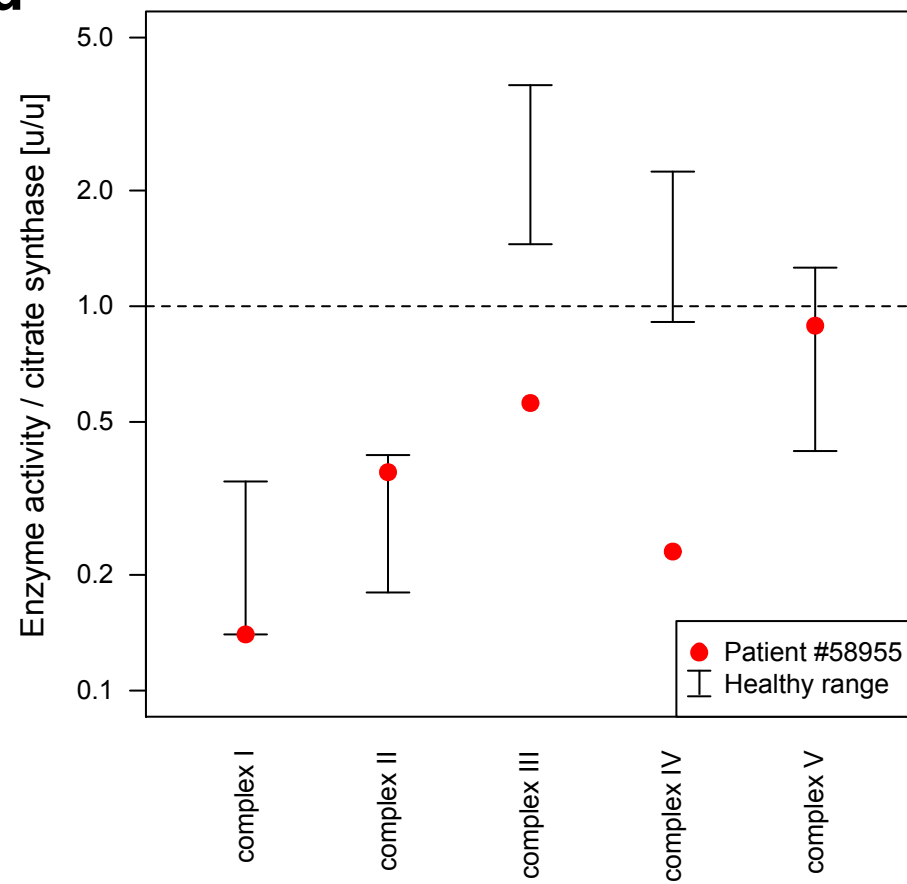

a**CLPP NM_006012.2****b****c****Patient #58955****d**

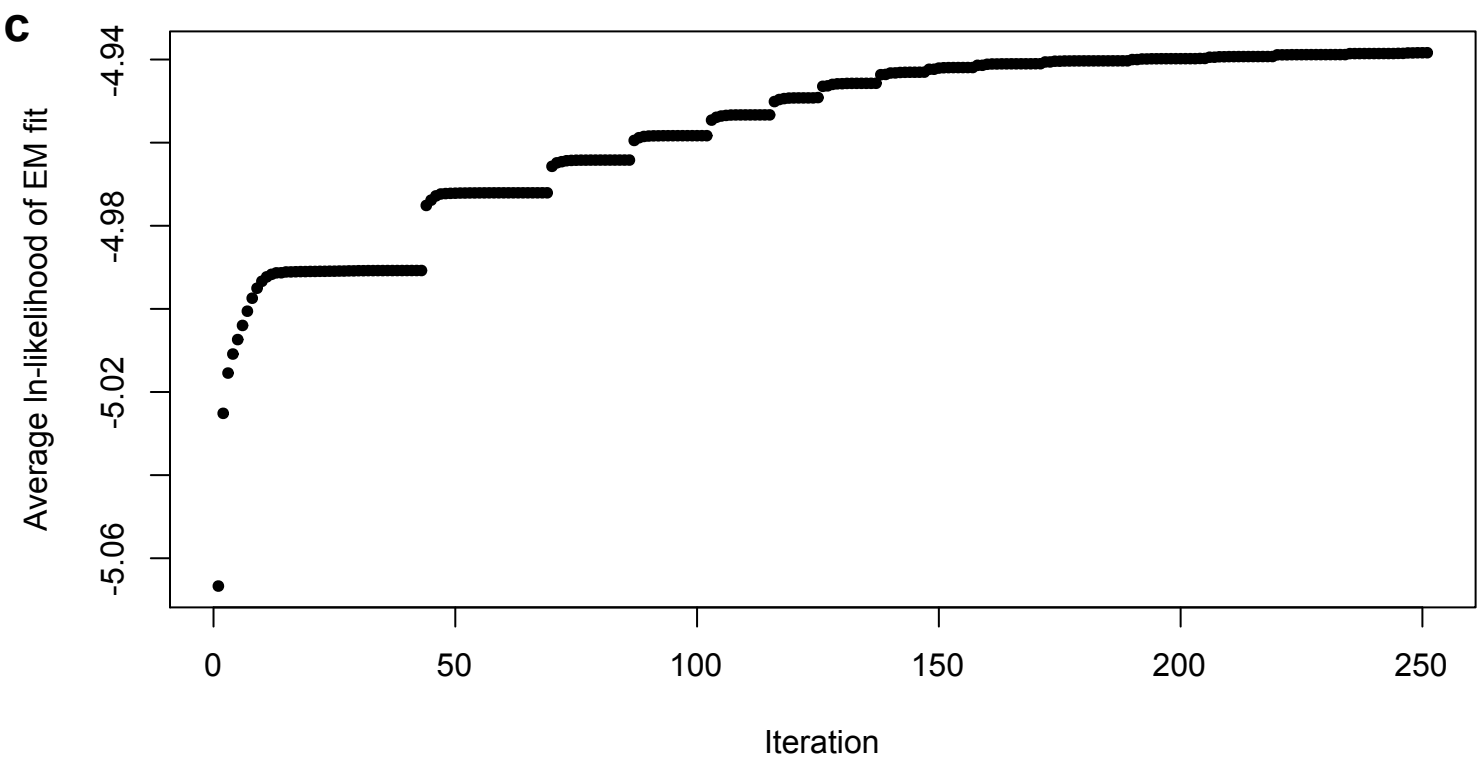
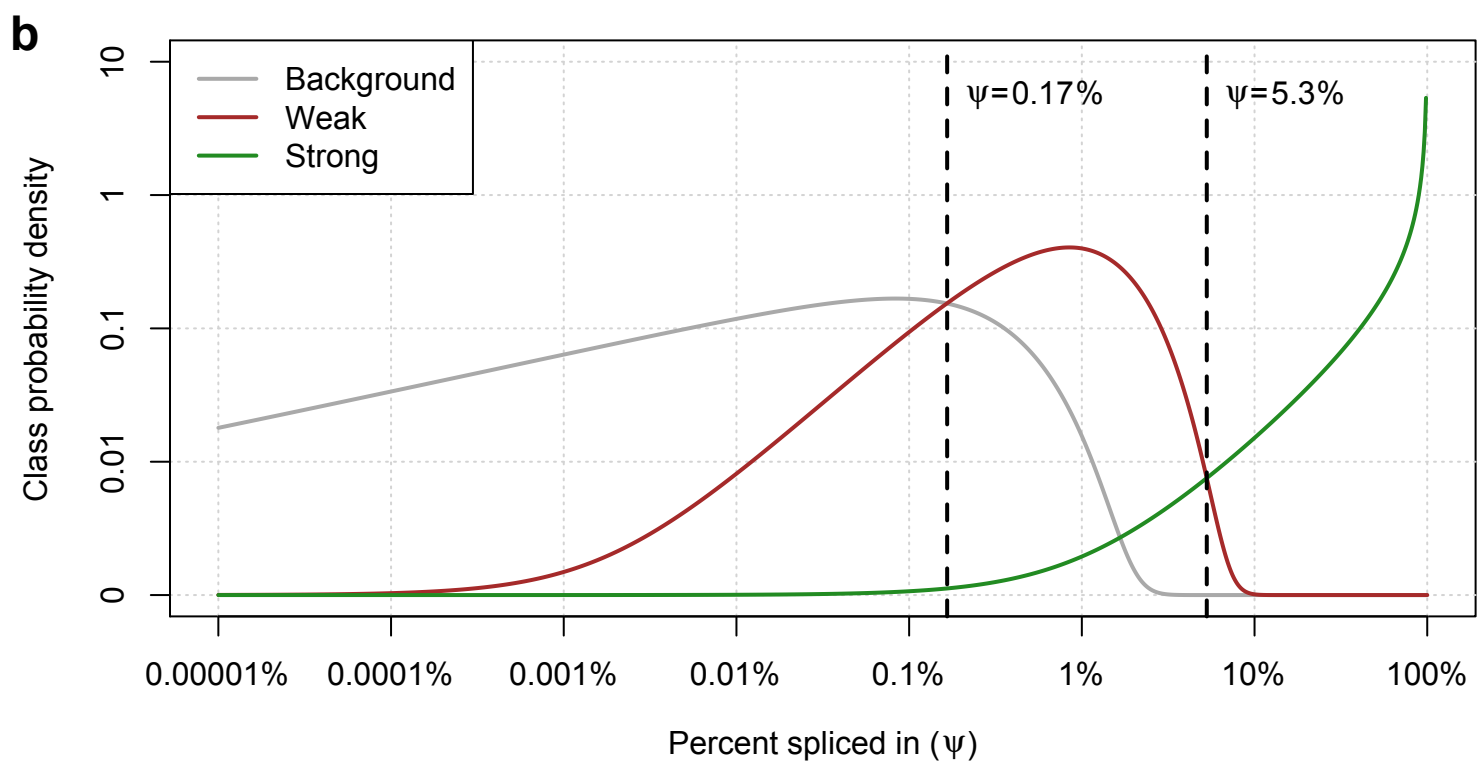
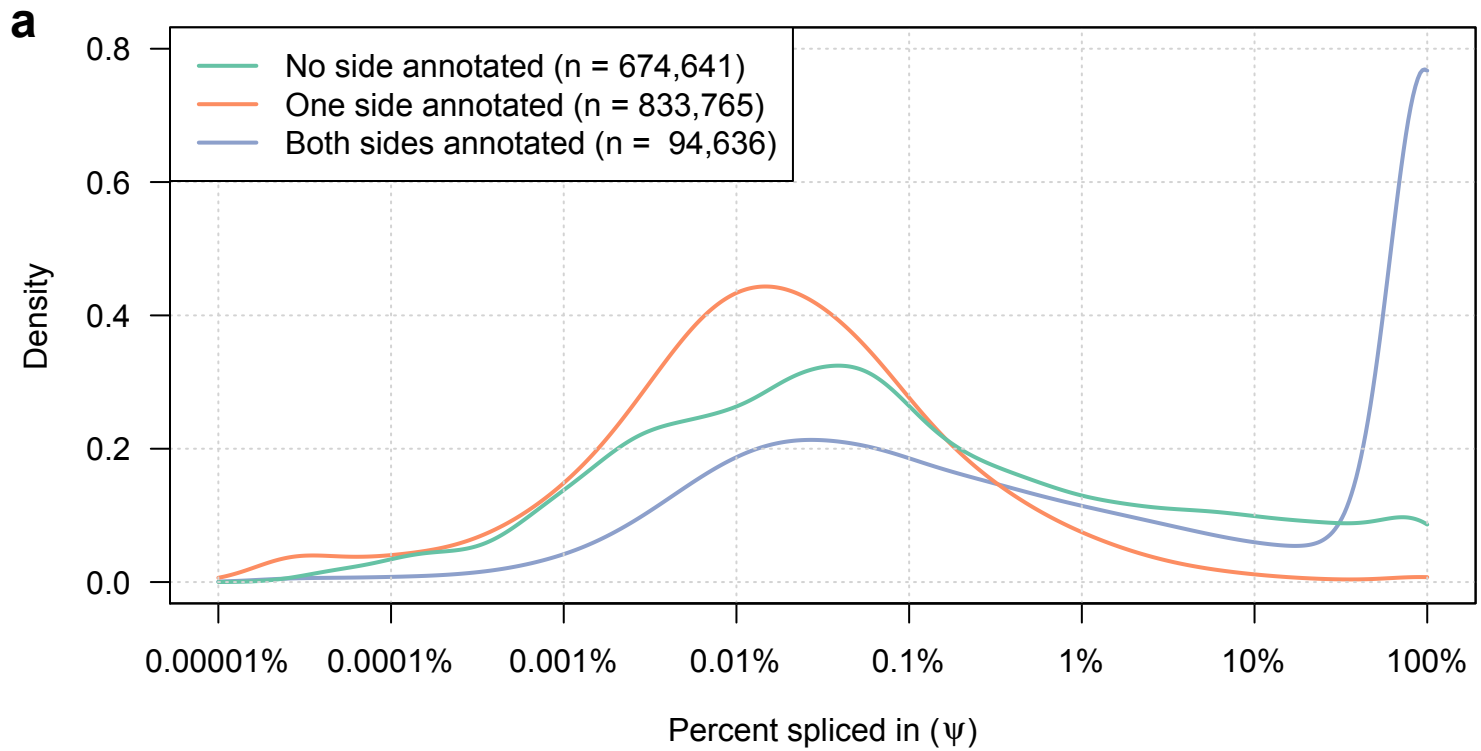

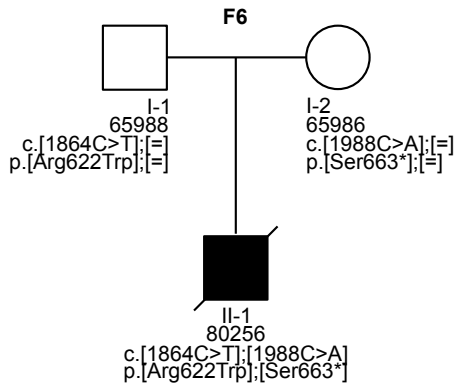
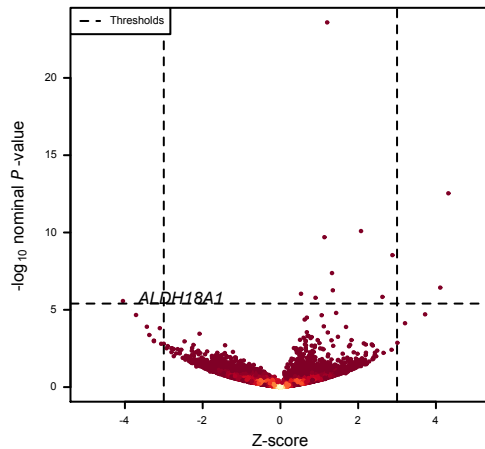
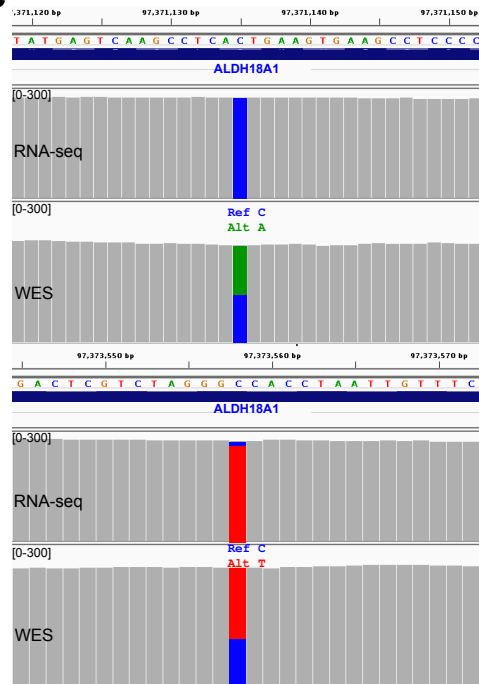
a**ALDH18A1 NM_002860.3****b****Patient #80256****c**

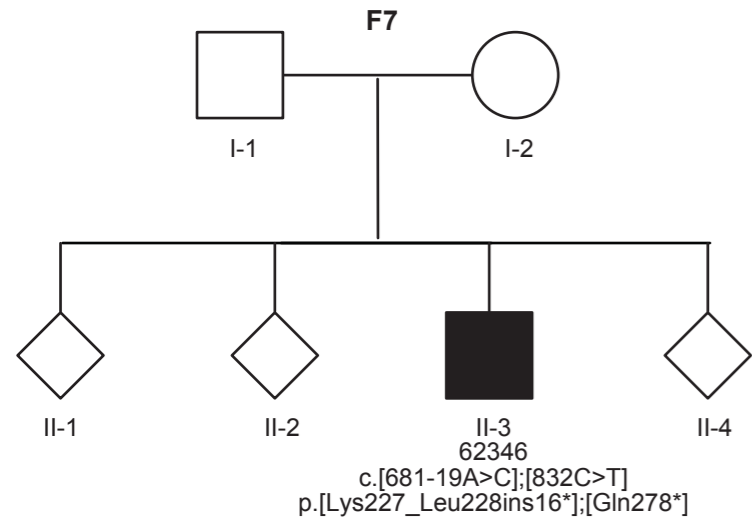
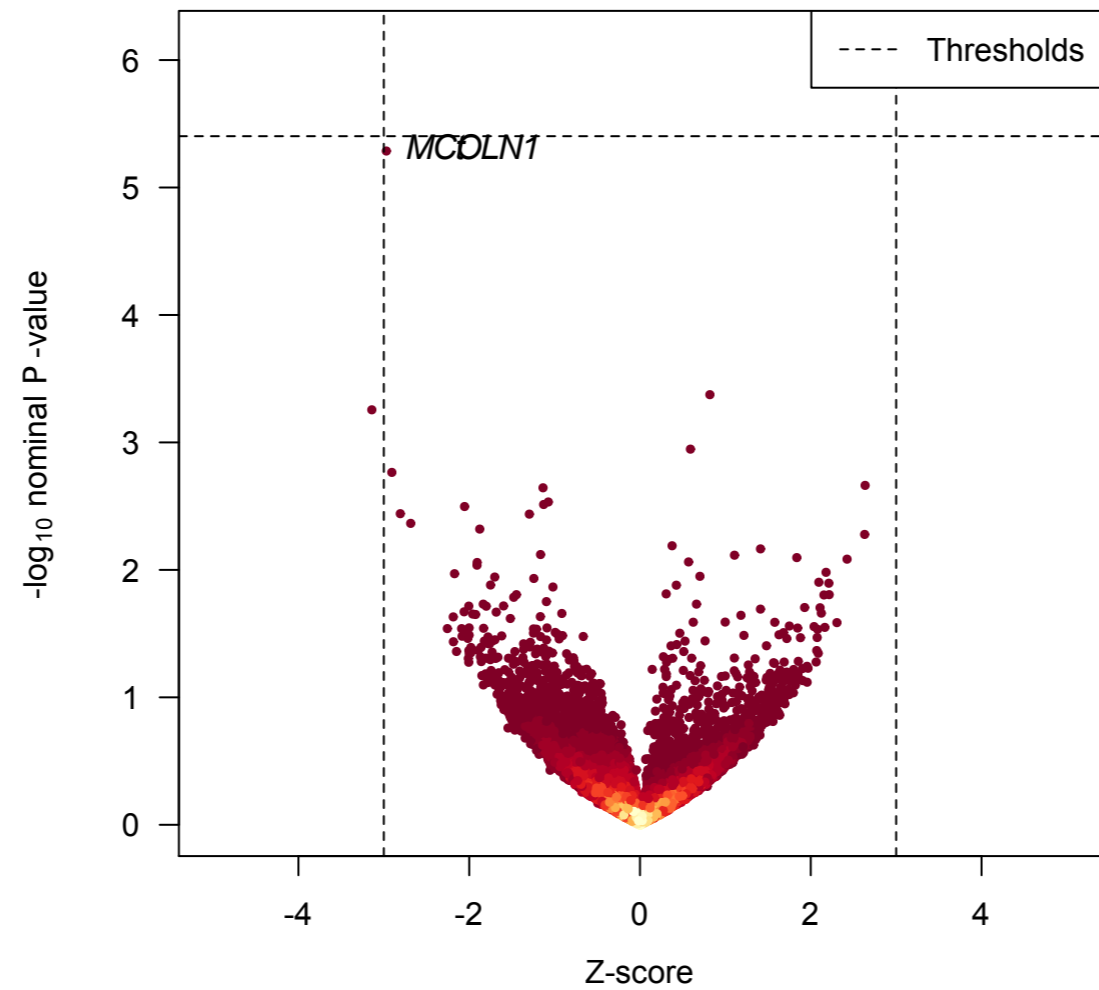
a**MCOLN1 NM_020533****b****Patient #62346****c****Patient #62346**